

Digital Caliper ABS Digimatic Caliper

Catalog No. E12021



New-series Digimatic calipers born from Mitutoyo's technologies accumulated for 30 years since development of digital calipers Equipped with **the electromagnetic induction type absolute encoder** applied for ABS coolant-proof calipers

- Patent registered (in Japan, USA, China, Germany, UK, France, Switzerland and India)
- Design patent pending (in Japan, USA, EU and China)

Mitutoyo

New

ABS Digimatic Caliper CD-AX/APX Series

A new series of cost-effective standard Digimatic caliper born of Mitutoyo's ground-breaking encoder technologies developed over the last 30 years. Now equipped with the same AOS (Advanced Onsite Encoder) induction type encoder used in top-of-the-line **ABS coolant-proof calipers**.

Thanks to the adoption of the **electromagnetic induction type ABS encoder**, this caliper can be used without concern for **contamination on the scale face during measurement**.

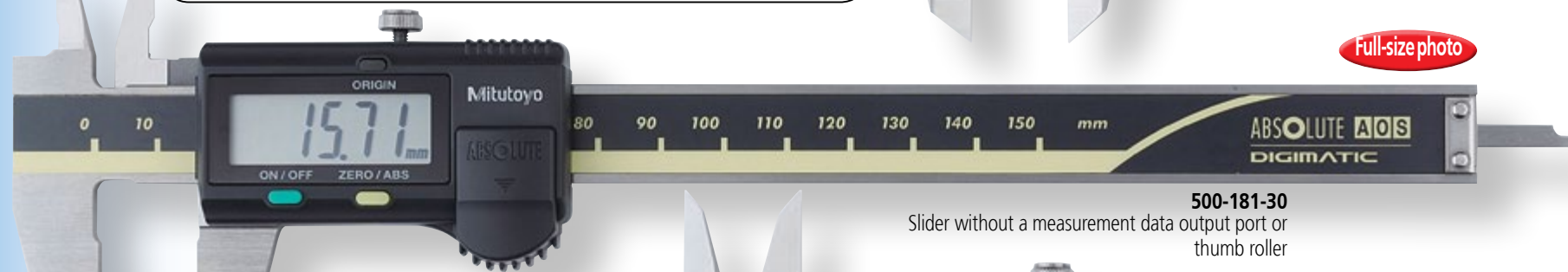
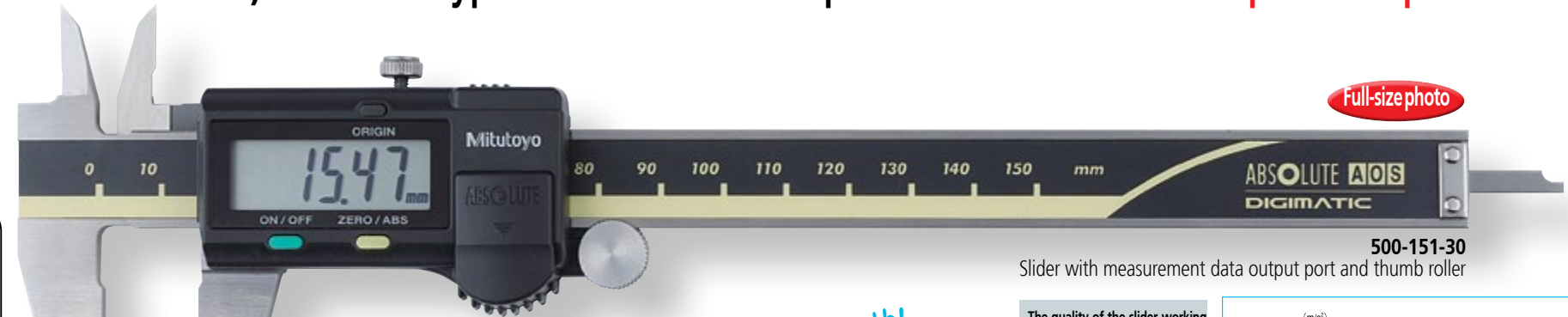
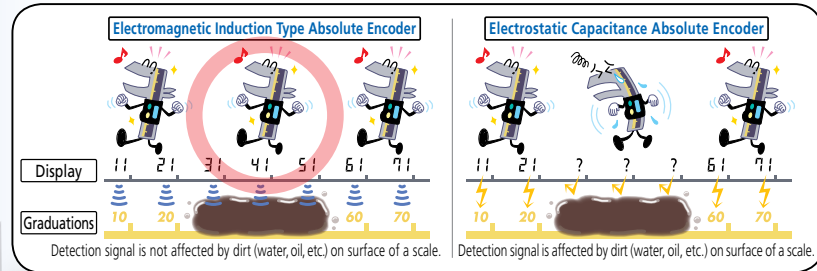

The quality of the slider working surface has improved with the latest machining technology.
 Ra: 0.071 μm
 Longitudinal direction

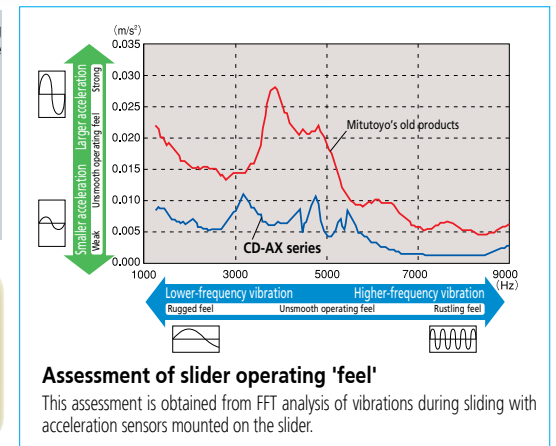

The slider provides **smooth, stable and comfortable operation**.

Font height: **9mm**
 Alleviation of fatigue with the high-contrast LCD

The ABS (absolute) scale **requires no origin setting** after power-on and **also has no limit to response speed**.

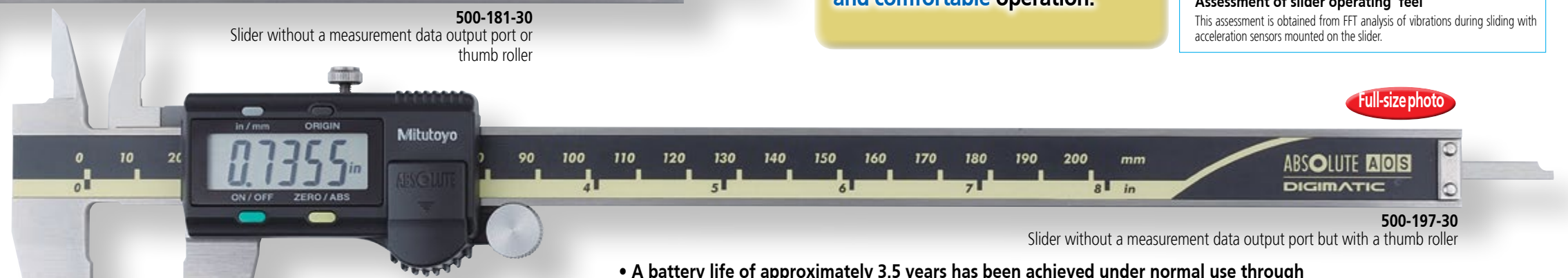
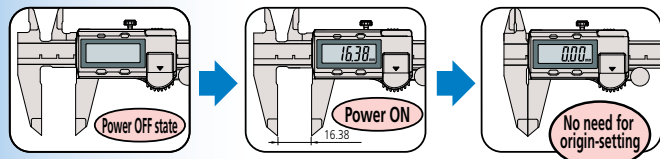

- A battery life of approximately 3.5 years has been achieved under normal use through the adoption of Mitutoyo's ABSOLUTE scale.
- The slider configuration features an ergonomic, thumb-friendly shape.
- Step-measurement capable.
- Carbide-tipped jaw models are ideally suited to the measurement of rough-machined workpieces, castings, grindstones, etc.
- The data output function allows integration into statistical process control and measurement systems.



An inspection certificate is included standard with each caliper.

ABSOLUTE™

Mitutoyo

Evolution of Mitutoyo's digital caliper

1983	1987	1988	1993	2000	2003	2005	2013
• The first digital caliper.	• A Digimatic-format measurement data output port is incorporated.	• The first solar-powered model, which never needs a new battery.	• Introduction of Mitutoyo's electrostatic capacitance ABSOLUTE encoder caliper.	• Introduction of an ABSOLUTE encoder caliper offering IP65-level coolant-proof performance.	• Introduction of an induction type ABSOLUTE encoder caliper offering IP67-level coolant-proof performance.	• Introduction of a solar-powered ABSOLUTE encoder caliper offering IP67-level coolant-proof performance.	• The AOS induction type ABSOLUTE encoder is introduced to a standard caliper. <i>New</i>

Common Specifications

- Resolution: 0.01mm
- Repeatability: 0.01mm (Quantizing error excluded)
- Power supply: Button-type silver oxide battery SR44 (No. 938882), 1 piece supplied as standard (The standard supplied battery is for the monitor.)
- Battery life: Approx. 3.5 years under normal use
- Maximum response speed: Unlimited

Functions

- **ABS (absolute) measurement function:** Enables absolute-mode measurement to be started without any zero-setting after switch-on. The absolute origin position can be set, or reset, with the ORIGIN switch at any time.
- **INC (incremental) measurement function:** Enables the display value to be set to zero, temporarily, at the current slider position to enable easy incremental-mode measurement.

Low battery alarm:

Indicates (with a 'B' symbol in the display) that the battery needs replacing. This allows timely battery replacement before the caliper becomes unusable.

External output function:

Allows measurement data to be exported using the optional data cable.

Hold function:

Allows a display value to be held using the optional Data Hold unit. (This function cannot be used along with the external output function.)

SPECIFICATIONS

Metric

Order No.	Range	Accuracy	Mass	Measurement data output port	Thumb roller	Remarks
500-150-30	0-100mm	±0.02mm	143 g	-	-	Depth bar ø1.9mm rod
500-180-30						-
500-151-30	0-150mm		168 g	-	-	Carbide-tipped jaws for outside measurement
500-154-30						Carbide-tipped jaws for outside and inside measurement
500-155-30						Carbide-tipped jaws for outside and inside measurement
500-158-30						Depth bar ø1.9mm rod
500-181-30	0-200mm	198 g	-	-	-	
500-152-30					-	
500-156-30					Carbide-tipped jaws for outside measurement	
500-157-30					Carbide-tipped jaws for outside and inside measurement	
500-182-30	-	-	-	-	-	-

Inch

Order No.	Range	Accuracy	Mass	Measurement data output port	Thumb roller	Remarks
500-170-30	0-4"	±0.001"	143 g	-	-	Depth bar ø3/40" rod
500-195-30						-
500-171-30	0-6"		168 g	-	-	Carbide-tipped jaws for outside measurement
500-174-30						Carbide-tipped jaws for outside and inside measurement
500-175-30						Carbide-tipped jaws for outside and inside measurement
500-178-30						Depth bar ø3/40" rod
500-196-30	0-8"	198 g	-	-	-	
500-159-30					Carbide-tipped jaws for outside measurement	
500-160-30					Carbide-tipped jaws for outside and inside measurement	
500-172-30					Carbide-tipped jaws for outside and inside measurement	
500-176-30	-	-	-	-	Carbide-tipped jaws for outside measurement	
500-177-30					Carbide-tipped jaws for outside and inside measurement	
500-197-30					-	
500-163-30					Carbide-tipped jaws for outside measurement	
500-164-30	-	-	-	-	-	Carbide-tipped jaws for outside and inside measurement

External View/Dimensions Chart

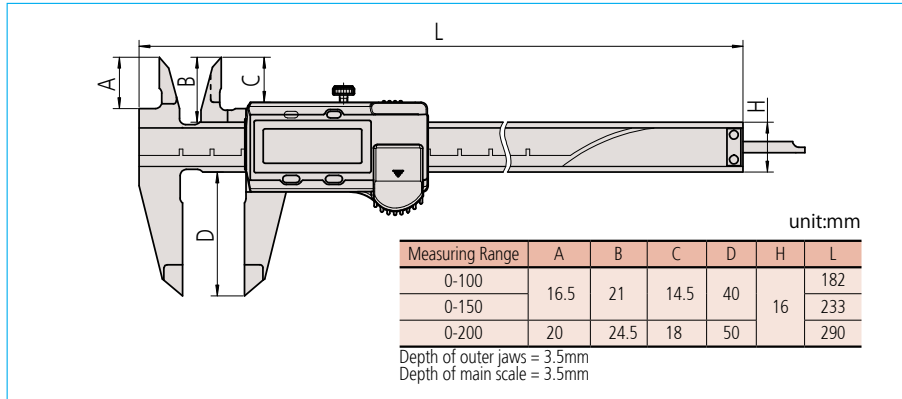

Export permission by the Japanese government may be required for exporting our products according to the Foreign Exchange and Foreign Trade Law. Please consult our sales office near you before you export our products or you offer technical information to a nonresident.

- Coordinate Measuring Machines
- Vision Measuring Systems
- Form Measurement
- Optical Measuring
- Sensor Systems
- Test Equipment and Seismometers
- Digital Scale and DRO Systems
- Small Tool Instruments and Data Management

Optional Accessories

These accessories are available only for those models with the measurement data output function.

Data Hold unit

Order No.959149

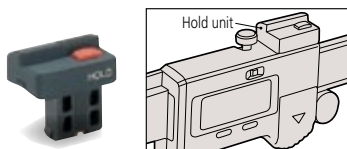

Connecting cable

Used for input tool DP-1VR or MUX-10F.

- 1m cable: Order No.959149
- 2m cable: Order No.959150



USB direct input tool

USB-ITN-C (2m): Order No.06ADV380C

U-WAVE-T dedicated connecting cable

- Cable for standard use: Order No.02AZD790C
- Cable for foot switch: Order No.02AZE140C

Mitutoyo Corporation

20-1, Sakado 1-Chome,
Takatsu-ku, Kawasaki-shi,
Kanagawa 213-8533, Japan
T +81 (0) 44 813-8230
F +81 (0) 44 813-8231
<http://www.mitutoyo.co.jp>

Note: All information regarding our products, and in particular the illustrations, drawings, dimensional and performance data contained in this pamphlet, as well as other technical data are to be regarded as approximate average values. We therefore reserve the right to make changes to the corresponding designs, dimensions and weights. The stated standards, similar technical regulations, descriptions and illustrations of the products were valid at the time of printing. Only quotations submitted by ourselves may be regarded as definitive.